

PROJECT	_____
TYPE	_____
SPECIFIER	_____
QUANTITY	_____
DATE	_____

## MAGIQ 2 CELL MICRO-DOT TRIMLESS

**A35780-** \_\_\_\_\_ - \_\_\_\_\_

base number    Color \_\_\_\_\_    Lens \_\_\_\_\_  
 Temperature    Options \_\_\_\_\_

- To build a product code in our configurator select the specify button on the base model # product page
- To build a manual product code on this datasheet choose from the options listed below in blue font and add the suffix to the base model #

### GENERAL

Series: Magiq Micro Dot  
 Subseries: Magiq 2 Cell Micro-Dot  
 Partner: Prolicht  
 Division: Architectural  
 Installation: Trimless  
 Product Type: Downlight  
 Mounting Location: Ceiling  
 Light Distribution: Downlight

### PHYSICAL

Shape: Rectangle  
 Length (mm): 70  
 Length (in): 2 ¾  
 Width (mm): 35  
 Width (in): 1 ⅜  
 Height (mm): 65  
 Height (in): 2 ⅞  
 Ceiling Thickness (mm): 12.5  
 Ceiling Thickness (in): 1/2  
 Min. Recessing Depth (mm): 100  
 Min. Recessing Depth (in): 3 15/16  
 Weight (kg): 0.241  
 Weight (lbs): 0.53  
 Fixture Finish: BLK  
 Fixture Material: Aluminum Die Cast  
 Cut-out Measurements: 82mm / 3 1/4" x 42mm / 1 5/8"  
 Upon Request: Unique Ceiling Thickness

### ELECTRICAL

Lamp Type: LED (Zhaga Standard)  
 Input Wattage (W): 9  
 Total Output Wattage (W): 6.6  
 Dimming: Tri-Mode (Non-Dimming and Phase Dimming (120Vac only) and 0-10V Dimming)  
 Driver Included: No  
 Driver Location: Remote  
 Driver Type: Constant Current - Universal  
 Driver Class: Class 2  
 Input Voltage (V): 120 - 277  
 Constant Current (MA): 1050

### LED

Number of LEDs: 2  
 Color Temperature (°K): 2700 / 3000 / 3500 / 4000  
 Max. Delivered Lumen (lm): 320 / 349 / 357 / 364  
 Nominal Lumen (lm): 440 / 465 / 470 / 480  
 CRI: >90 CRI  
 Lamp Life (hrs): 50000  
 Upon Request: Special Color Temperature

### OPTICAL

Optic°: 22 / 38  
 Upon Request: Special Beam Angles

### RATINGS AND CERTIFICATIONS

Certified By: CSA Certified to UL and CSA Standards  
 IP rating: IP44

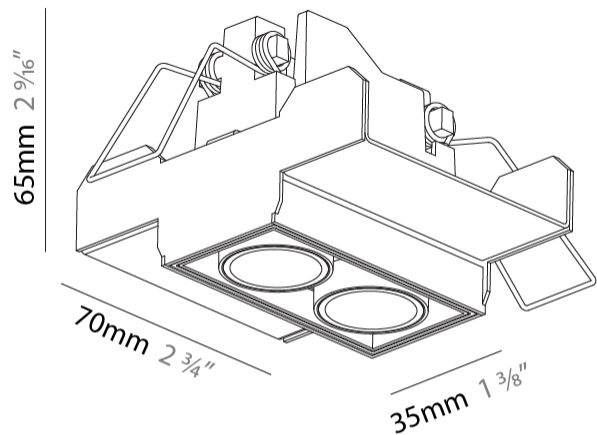
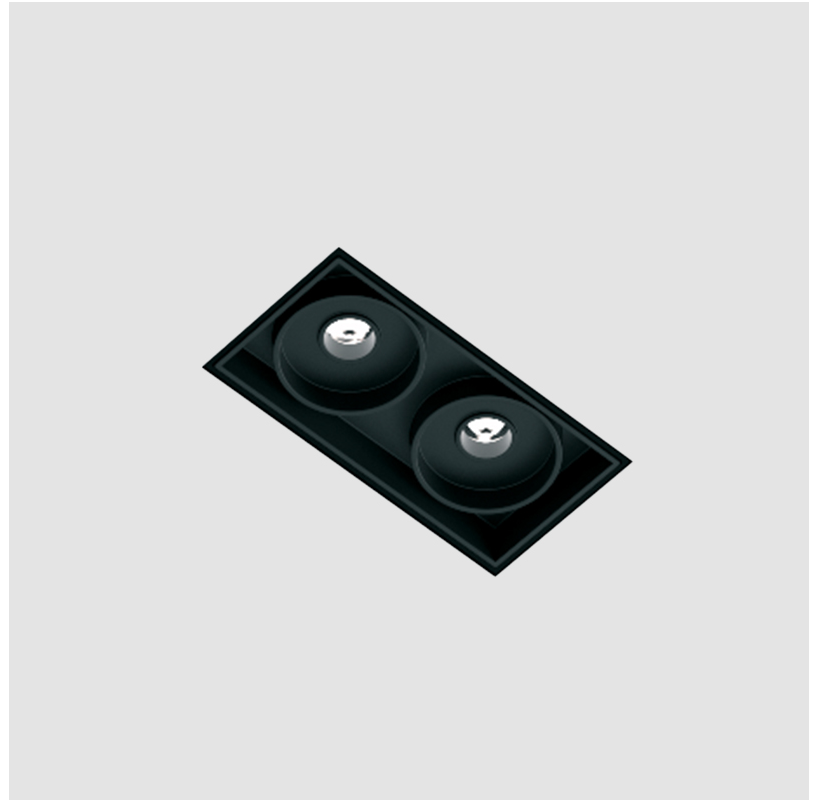

82mm x 82mm  
3 1/4" x 3 1/4"

120mm  
4 3/4"

12 1/2mm  
1/2"



## MAGIQ 2 CELL MICRO-DOT TRIMLESS

A35780-

PROJECT	_____
TYPE	_____
SPECIFIER	_____
QUANTITY	_____
DATE	_____

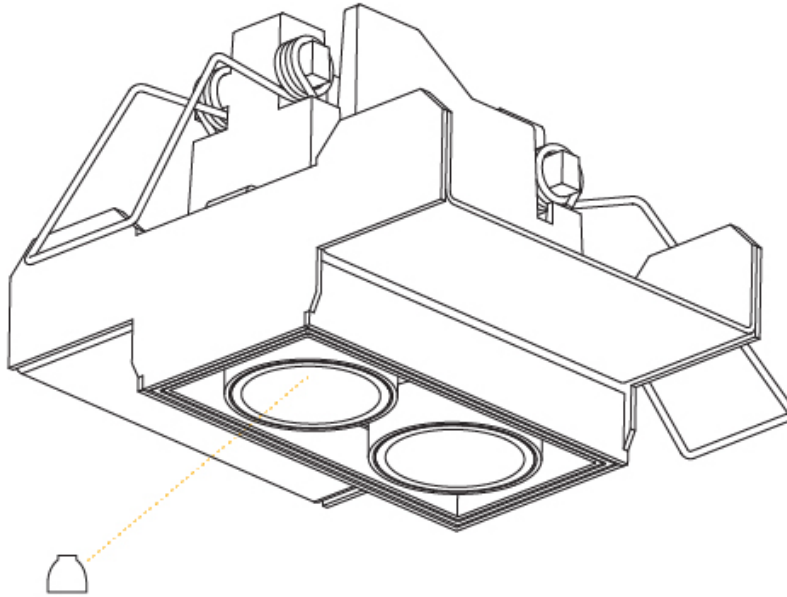

## MAGIQ 4 CELL MICRO-DOT TRIMLESS

**A35782-** \_\_\_\_\_

base number    Color    Lens  
 \_\_\_\_\_    Temperature    Options

PROJECT
TYPE
SPECIFIER
QUANTITY
DATE

- To build a product code in our configurator select the specify button on the base model # product page
- To build a manual product code on this datasheet choose from the options listed below in blue font and add the suffix to the base model #

### GENERAL

Series: Magiq Micro Dot  
 Subseries: Magiq 4 Cell Micro-Dot  
 Partner: Prolicht  
 Division: Architectural  
 Installation: Trimless  
 Product Type: Downlight  
 Mounting Location: Ceiling  
 Light Distribution: Downlight

### PHYSICAL

Shape: Rectangle  
 Length (mm): 135  
 Length (in): 5 <sup>5</sup>/<sub>16</sub>  
 Width (mm): 35  
 Width (in): 1 <sup>3</sup>/<sub>8</sub>  
 Height (mm): 65  
 Height (in): 2 <sup>9</sup>/<sub>16</sub>  
 Ceiling Thickness (mm): 12.5  
 Ceiling Thickness (in): 1/2  
 Min. Recessing Depth (mm): 100  
 Min. Recessing Depth (in): 3 <sup>15</sup>/<sub>16</sub>  
 Weight (kg): 0.403  
 Weight (lbs): 0.89  
 Fixture Material: Aluminum Die Cast  
 Cut-out Measurements: 142mm / 5 9/16" x 42mm / 1 5/8"  
 Upon Request: Unique Ceiling Thickness

### ELECTRICAL

Lamp Type: LED (Zhaga Standard)  
 Input Wattage (W): 14.3  
 Total Output Wattage (W): 13.3  
 Dimming: Tri-Mode (Non-Dimming and Phase Dimming (120Vac only) and 0-10V Dimming)  
 Driver Included: No  
 Driver Location: Remote  
 Driver Type: Constant Current - Universal  
 Driver Class: Class 2  
 Housing: See components  
 Input Voltage (V): 120 - 277  
 Constant Current (MA): 1050

### LED

Number of LEDs: 4  
 Color Temperature (°K): 2700 / 3000 / 3500 / 4000  
 Max. Delivered Lumen (lm): 640 / 694 / 706 / 720  
 Nominal Lumen (lm): 880 / 954 / 940 / 990  
 CRI: >90 CRI  
 Lamp Life (hrs): 50000  
 Upon Request: Special Color Temperature

### OPTICAL

Optic°: 22 / 38  
 Upon Request: Special Beam Angles

### RATINGS AND CERTIFICATIONS

Certified By: CSA Certified to UL and CSA Standards  
 IP rating: IP44

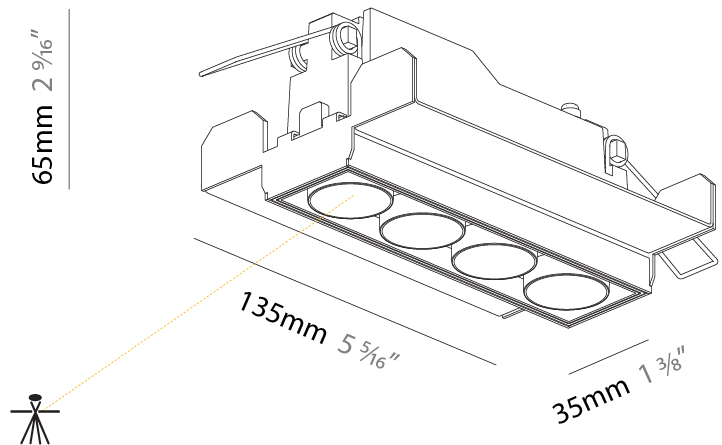

## MAGIQ 4 CELL MICRO-DOT TRIMLESS

A35782-

PROJECT	_____
TYPE	_____
SPECIFIER	_____
QUANTITY	_____
DATE	_____

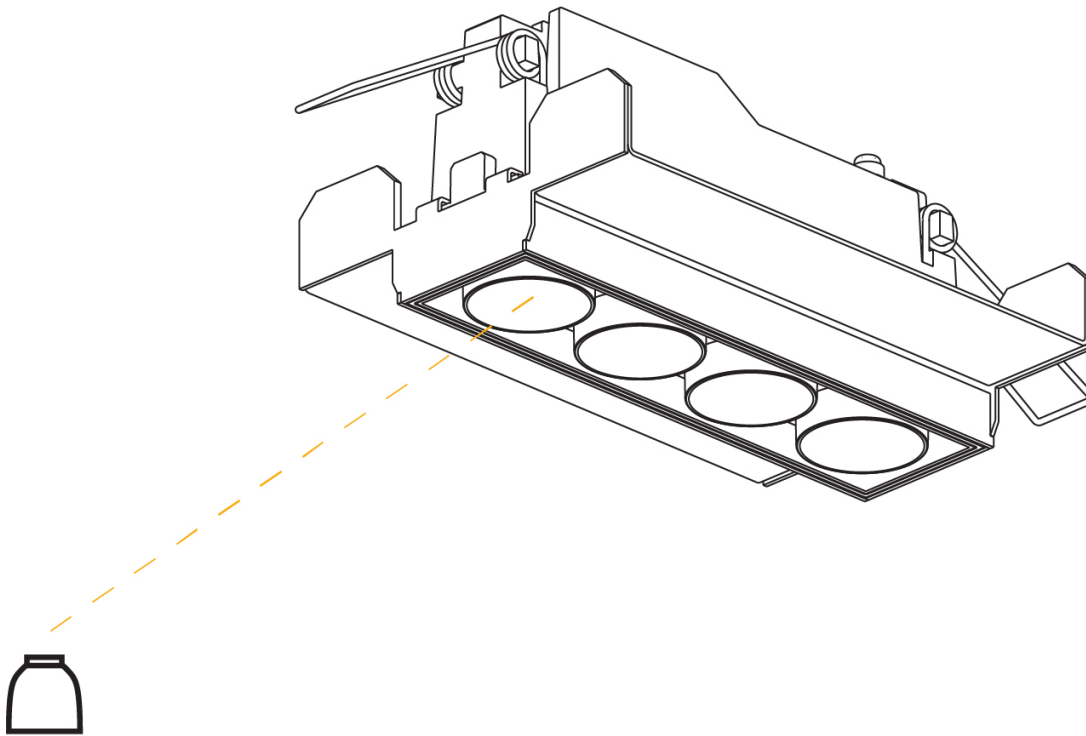

PROJECT	
TYPE	
SPECIFIER	
QUANTITY	
DATE	

## MAGIQ 8 CELL MICRO-DOT TRIMLESS

**A35783-** -

base number    Color    Lens  
 Temperature    Options

- To build a product code in our configurator select the specify button on the base model # product page
- To build a manual product code on this datasheet choose from the options listed below in blue font and add the suffix to the base model #

### GENERAL

Series: Magiq Micro Dot  
 Subseries: Magiq 8 Cell Micro-Dot  
 Partner: Prolicht  
 Division: Architectural  
 Installation: Trimless  
 Product Type: Downlight  
 Mounting Location: Ceiling  
 Light Distribution: Downlight

### PHYSICAL

Shape: Rectangle  
 Length (mm): 267  
 Length (in): 10 1/2  
 Width (mm): 35  
 Width (in): 1 3/8  
 Height (mm): 64  
 Height (in): 2 1/2  
 Ceiling Thickness (mm): 12.5  
 Ceiling Thickness (in): 1/2  
 Min. Recessing Depth (mm): 100  
 Min. Recessing Depth (in): 3 15/16  
 Weight (kg): 0.737  
 Weight (lbs): 1.61  
 Fixture Material: Aluminum Die Cast  
 Cut-out Measurements: 272mm / 10 11/16" x 42mm / 1 5/8"  
 Upon Request: Unique Ceiling Thickness

### ELECTRICAL

Lamp Type: LED (Zhaga Standard)  
 Input Wattage (W): 30.2  
 Total Output Wattage (W): 25.9  
 Dimming: Tri-Mode (Non-Dimming and Phase Dimming (120Vac only) and 0-10V Dimming)  
 Driver Included: No  
 Driver Location: Remote  
 Driver Type: Constant Current - Universal  
 Driver Class: Class 2  
 Input Voltage (V): 120 - 277  
 Constant Current (MA): 1050

### LED

Number of LEDs: 8  
 Color Temperature (°K): 2700 / 3000 / 3500 / 4000  
 Max. Delivered Lumen (lm): 1281 / 1388 / 1412 / 1441  
 Nominal Lumen (lm): 1761 / 1908 / 1941 / 1980  
 CRI: >90 CRI  
 Lamp Life (hrs): 50000  
 Upon Request: Special Color Temperature

### OPTICAL

Optic°: 21 / 38  
 Upon Request: Special Beam Angles

### RATINGS AND CERTIFICATIONS

Certified By: CSA Certified to UL and CSA Standards  
 IP rating: IP44

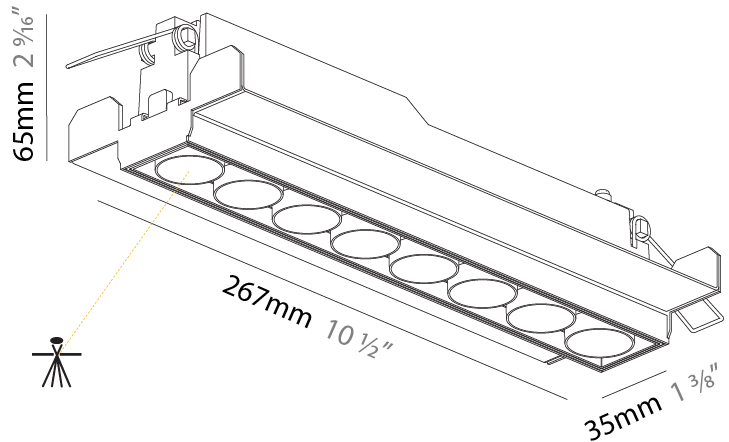

272mm x 42mm  
 10 11/16" x 1 5/8"

100mm  
 3 15/16"

12 1/2mm  
 1/2"



## MAGIQ 8 CELL MICRO-DOT TRIMLESS

A35783-

PROJECT	_____
TYPE	_____
SPECIFIER	_____
QUANTITY	_____
DATE	_____

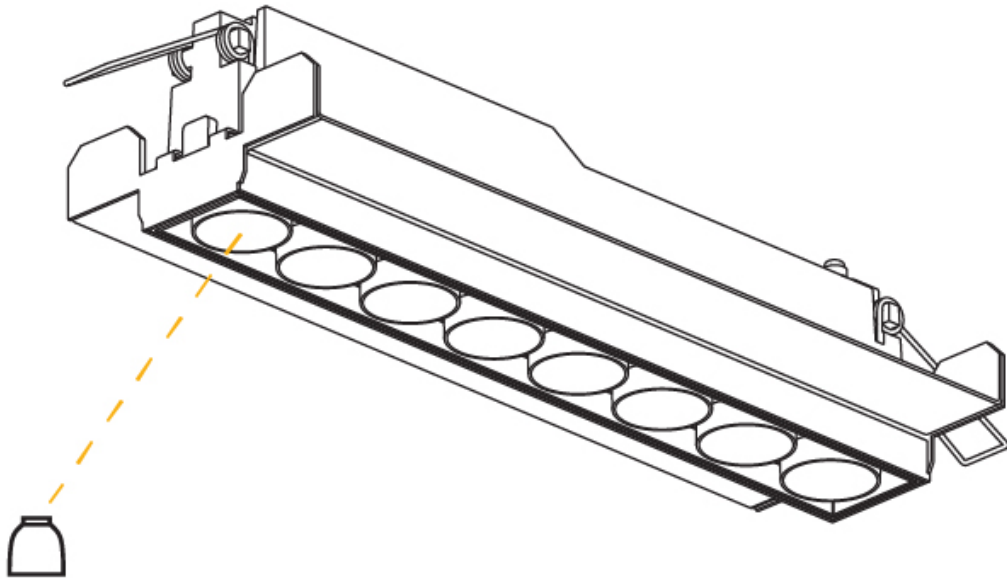

PROJECT

TYPE

SPECIFIER

QUANTITY

DATE

### Fixture Finish

Black - BLK (BLK)



**Digital:** Not all screens are calibrated the same, and therefore, colors will appear differently between screens.





































































**Physical:** When texture is involved, there will be variations in color, character and tone within a product series and between product families.

**Champagne Cream, Copper Mine, Ancient Bronze + Jazz Gold:** These finishes have slight fading from specific powder coating production. Each luminaire will slightly vary.













PROJECT	
TYPE	
SPECIFIER	
QUANTITY	
DATE	











### LEGEND

 floor-mounted	 pivotable	 special LED (upon request) RGB, RGBW, tunable, gold+, meat+, art+, fashion+
 wall and ceiling: recessed and surface mounted	 rotating	 warm dim / natural dimming LED
 ceiling-mounted and wall-mounted	 illuminate tilted	 rechargeable battery powered
 wall-mounted	 color of suspension cable	 fixture with natural vivid LED (upon request)
 omni-directional light distribution	 length of suspension cable	 color rendering index
 direct light distribution	 reflector degree selection	 color temperature
 direct/indirect light distribution	 super spot	 lumen (luminous flux)
 indirect light distribution	 lens	 efficacy (lumens per watt)
 asymmetric light distribution	 lens pack	 Unified Glare Rating (UGR) range from 5-40
 aura light distribution	 shine ring	 marine grade (AISI 316 stainless steel)
 round wall or ceiling cut-out	 integrated shine ring with diffuser	 walk on
 square wall or ceiling cut-out	 free individual colors 01-29	 drive on
 the supplied jig specifies the cutout dimensions	 individual colors: 00 (free of charge), 01-25 (extra charge)	 Dark Sky Compliance
 minimum distance (meters) lamp - object	 luminaire part to be colored (F1)	 Americans with Disabilities Act (less than 4" off the wall located between 27"-84" from floor)
 recessed depth	 luminaire part to be colored (F2)	 lamp protected against explosion
 ceiling thickness in mm	 luminaire part to be colored (F3)	 blown glass using traditional methods by master glass blower
 ceiling thickness selection	 luminaire part to be colored (F4)	 acoustic material
 dimmable DP (phase), DV (0-10V), DD (dali), DS (step-dim)	 luminaire part to be colored (F5)	 protection class I, protection insulation
 included or excluded LED driver/transformer/control gear	 color of 3-circuit adaptor	 protection class II, protection insulation
 separately switchable	 indirect diffuser	 ETL Certified to UL and CSA Standards
 sensor	 direct diffuser	 UL Certified to UL and CSA Standards
 remote control	 ball-proof (upon request)	 CSA Certified to UL and CSA Standards
 available upon request	 accessory	 Certified for North American Standards

### IP RATING

 IP20	protected against ingress of solid bodies greater than 12.5mm (finger)
 IP33	protected against ingress of solid bodies greater than 2.5mm protected against sprays of water up to 60 degrees from the vertical (rain)
 IP40	protected against ingress of solid bodies greater than 1mm (wire) no protection against the ingress of moisture
 IP43	protected against ingress of solid bodies greater than 1mm (wire) protected against sprays of water up to 60 degrees from the vertical (rain)
 IP44	protected against ingress of solid bodies greater than 1mm (wire) protected against water splashed from all directions
 IP54	protected against limited ingress of dust (wet rooms/covered outdoor areas) protected against water splashed from all directions
 IP65	protected against ingress of dust protected against jets of water
 IP66	protected against ingress of dust protected against powerful jets of water or heavy seas
 IP67	protected against ingress of dust protected against immersion of water between 15cm - 1m for 30 minutes
 IP68	protected against ingress of dust protected against immersion of water under pressure for long periods

### IK RATING

 IK01	protected against 0.14 joules impact (equivalent to 0.25kg mass dropped from 56mm above the surface)
 IK02	protected against 0.2 joules impact (equivalent to 0.25kg mass dropped from 80mm above the surface)
 IK03	protected against 0.35 joules impact (equivalent to 0.25kg mass dropped from 140mm above the surface)
 IK04	protected against 0.5 joules impact (equivalent to 0.25kg mass dropped from 200mm above the surface)
 IK05	protected against 0.7 joules impact (equivalent to 0.25kg mass dropped from 280mm above the surface)
 IK06	protected against 1 joules impact (equivalent to 0.25kg mass dropped from 400mm above the surface)
 IK07	protected against 2 joules impact (equivalent to 0.5kg mass dropped from 400mm above the surface)
 IK08	protected against 5 joules impact (equivalent to 1.7kg mass dropped from 300mm above the surface)
 IK09	protected against 10 joules impact (equivalent to 5.0kg mass dropped from 200mm above the surface)
 IK10	protected against 20 joules impact (equivalent to 5.0kg mass dropped from 400mm above the surface)